

The **REVSPEC**
PRIMES

PR-N021

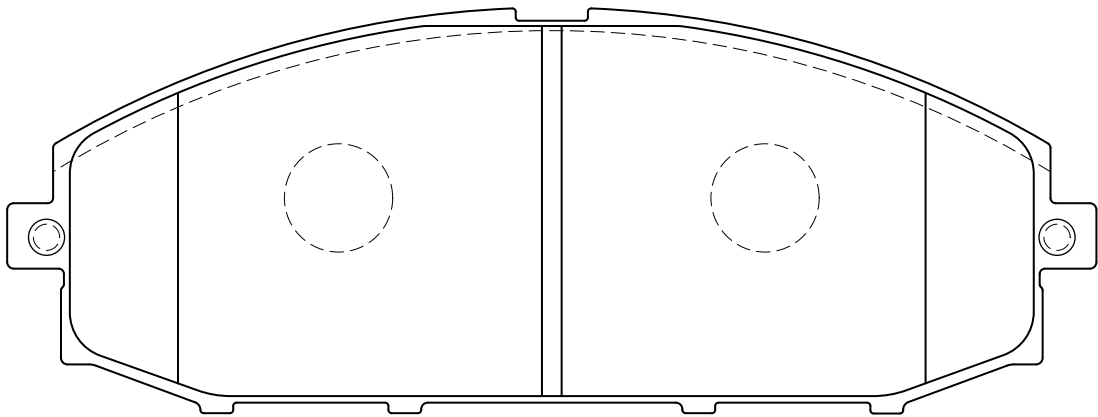
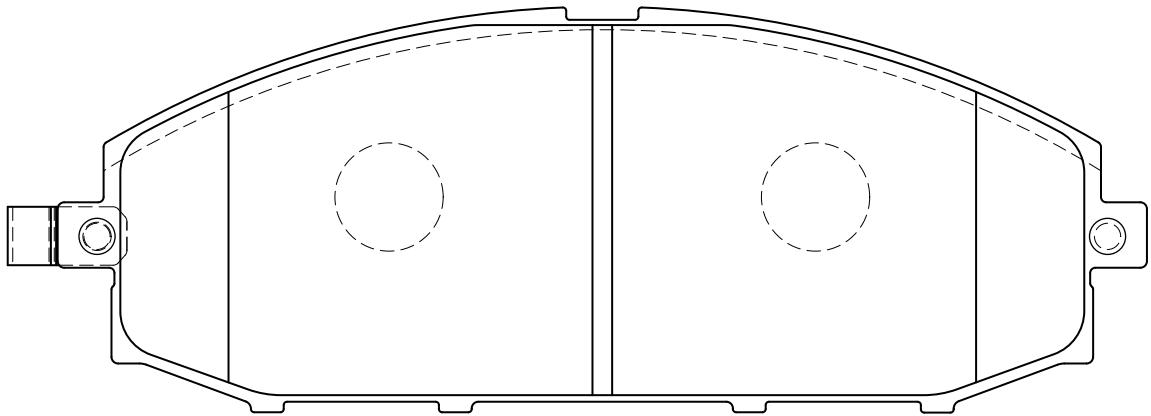

W:166 × H:58 × T:19