

The **REVSPEC**
PRIMES

PR-N518

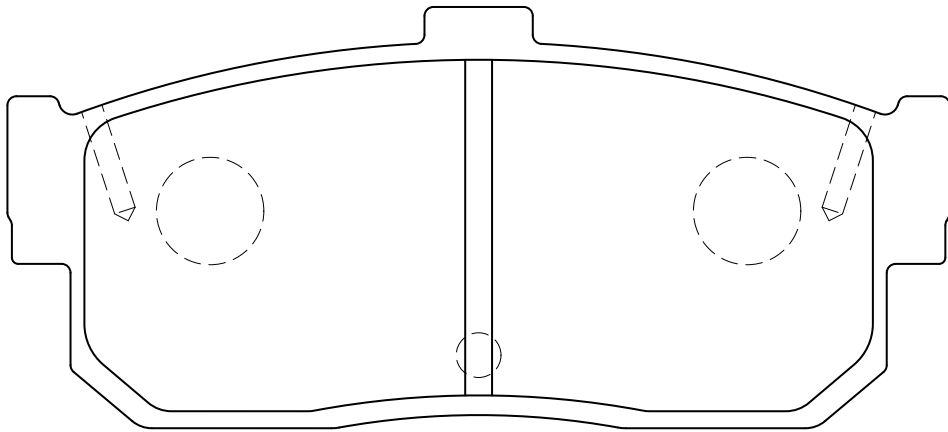
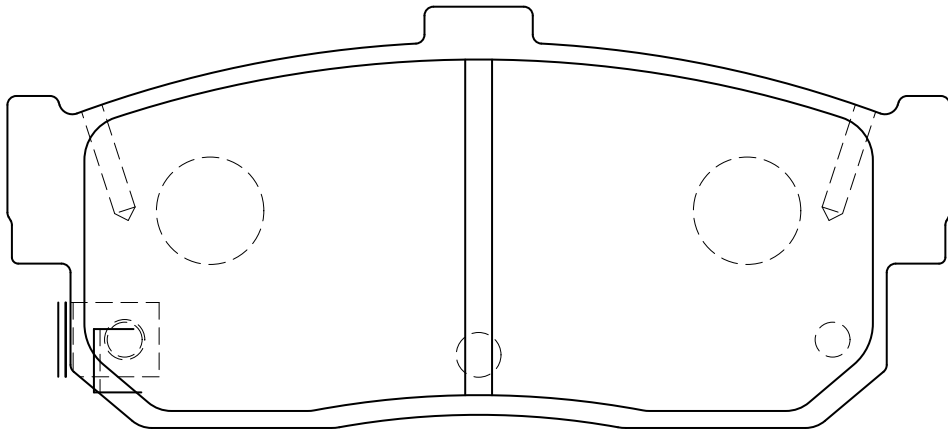

W:105.3 × H:45.5 × T:16.5