

The **REVSPEC**
PRIMES

PR-N606

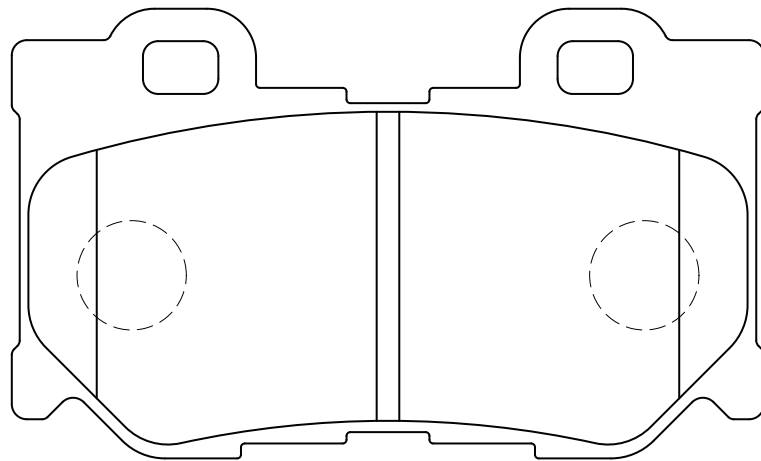
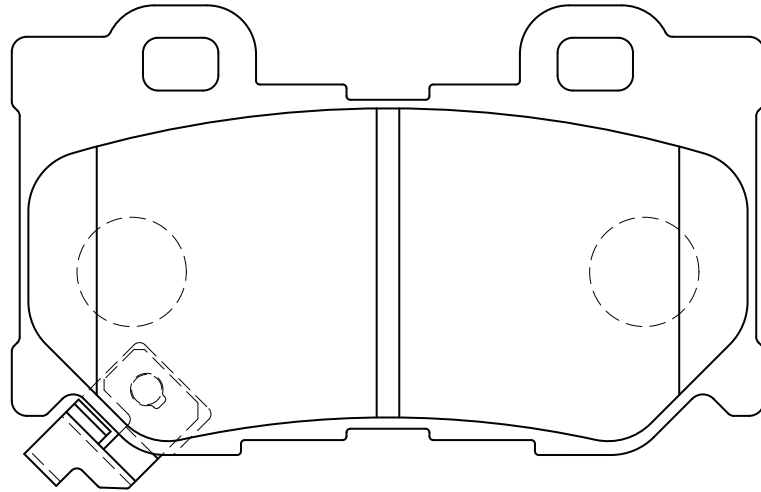

W:99.8 × H:59.6 × T:13.8